



Vantage Select Boost™

Part# 39509

Special Unit - Not for all Vehicles

WARNING! This system is for use with vehicles equipped with Full-Time Power Brakes ONLY. Use with vehicles not equipped with Full-Time Power Brakes may result in insufficient braking.

To determine if you have Full-Time Power Assist Brakes, follow these steps:

1. Turn your tow vehicle on while in the parked position. Let the vehicle run for a minimum of 5 seconds
2. Turn the vehicle completely off
3. Use your foot to pump the brake pedal five times
4. If the brake pedal is relatively easy to push all five times and does not become gradually harder each time you press the brake pedal the Boost™ system that you have purchased is the correct unit for your tow vehicle

If the brake pedal becomes noticeably harder each time you pump the brake pedal the BrakeBuddy® Boost™ is NOT the right system for your tow vehicle. In this circumstance you need a standard BrakeBuddy® Classic™ (Part# 39499) or BrakeBuddy® Vantage Select™ (Part# 39504). Please call your dealer or call BrakeBuddy® at (800) 470-2287 for exchange information

5. After determining that you have the correct system read and observe the rest of the instructions thoroughly before use

**If you have questions please call
BrakeBuddy® at (800) 470-2287**

You can also contact your vehicle manufacturer's service department and provide them with this sheet if you are unsure

Most Trusted • Best Performing • Easiest To Use
(800) 470-2287 | www.BrakeBuddy.com



Vantage Select Boost™



Phone (800) 470-2287

Brakebuddy.com

TABLE OF CONTENTS

Congratulations on the purchase of your new BrakeBuddy®! The BrakeBuddy® was designed and built as an auxiliary braking system to operate in conjunction with the existing braking system in your towed vehicle.

Use of the BrakeBuddy® in a manner inconsistent with these instructions may result in damage to your vehicle, serious injury or death. You must read and understand these instructions prior to the use of this product.

If you have any questions after reading these instructions, please call BrakeBuddy® customer service at 1 800-470-2287.

CONTENTS

Break Away Installation	Page 2
Setup	Page 4
Operation Instructions	Page 6
Removal Instructions	Page 8
Troubleshooting	Page 9
Warranty	Page 10

Remove the BrakeBuddy® and components from the shipping carton. The complete system consists of:

- Main BrakeBuddy® Unit**
- Clevis Assembly**
- Handle and Knob**
- Remote Alert System**
- Breakaway System**

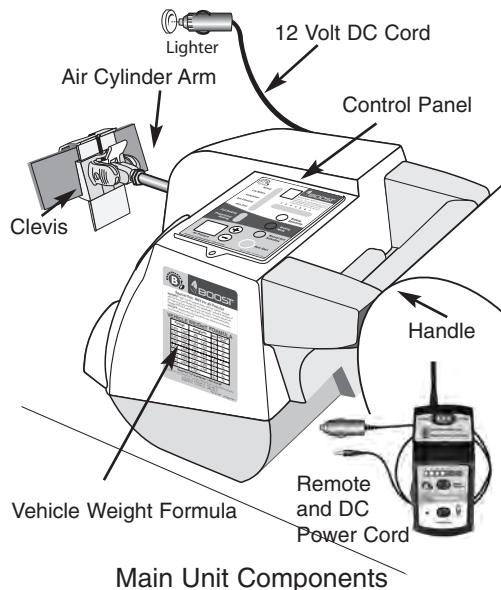

Breakaway Contents

- (A) 1, 1/16" coiled break-away cable with one large and one small clip on the ends
- (B) 1 junction box with wiring harness
- (C) 1 strap clamp
- (D) 2 hex socket head cap screws
- (E) 2 flat washers
- (F) 2 lock washers
- (G) 2 sheet metal screws
- (H) 2 grommets
- (I) 5 nylon ties
- (J) 1 loose velcro patch

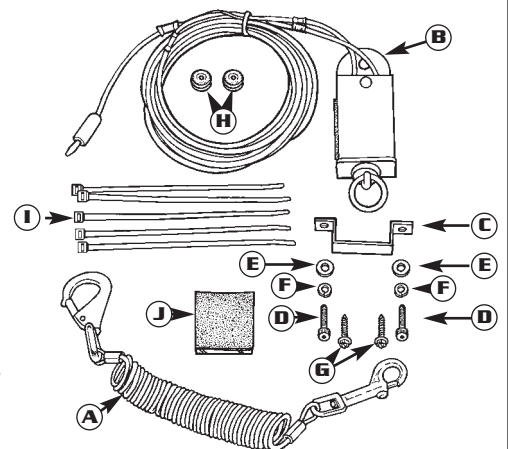

Breakaway System Components



BREAK AWAY INSTALLATION

The Break-Away is an important part of the BrakeBuddy system and is required by law in most states. Do not operate your BrakeBuddy without a properly functioning Break-Away.

Installing Junction Box

1. Find a convenient, sturdy place on the front of your towed vehicle to mount the junction box (B). This should be installed on the driver's side of the vehicle if possible.
2. Clean the mounting surface and attach the velcro patch (J) (Fig. 2).
3. Attach the junction box (B) to the velcro patch (J) so the pin with the ring faces forward and the wiring harness feeds back into the engine compartment.
4. Place the mounting bracket (C) over the junction box (B) and mark the hole locations to be drilled and tapped.
5. Remove bracket (C) and junction box (B). Drill marked holes with a 1/8" metal drill bit.
NOTE: For thin sheet metal or plastic, it may be necessary to reinforce the plastic or thin metal to insure the bracket will not separate from the vehicle when the break-away pin is pulled. If you are going to drill through thicker metal, use hex socket head capscrews (D). You will need to drill a hole using a #25 drill bit and tap the hole using a 10-24 tap.
6. Replace the junction box (B) and attach the bracket (C) using hex socket head capscrews (D) or sheet metal screws (G) provided (Fig. 3).
7. Locate a place in the firewall that will allow the wiring harness to be fed through into the passenger compartment of the towed vehicle. Use of an existing hole would be most convenient.
8. If there is no existing hole, drill a 15/32" diameter hole through the firewall (Fig. 4 / K).

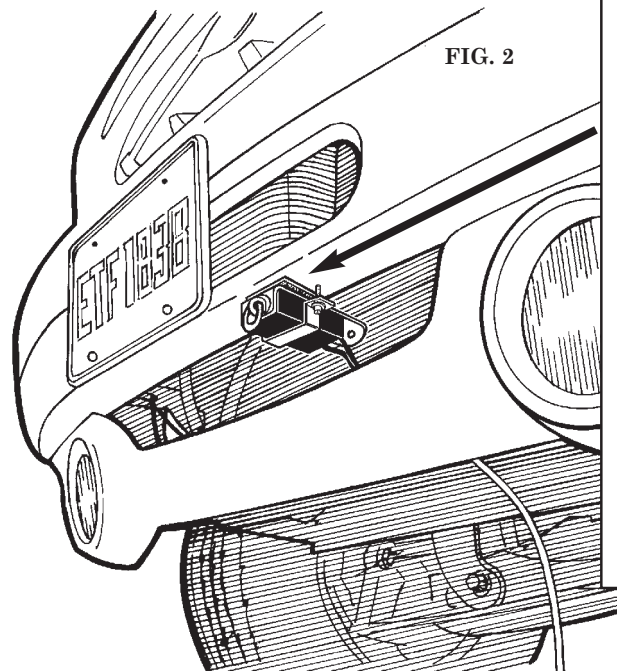

FIG. 2

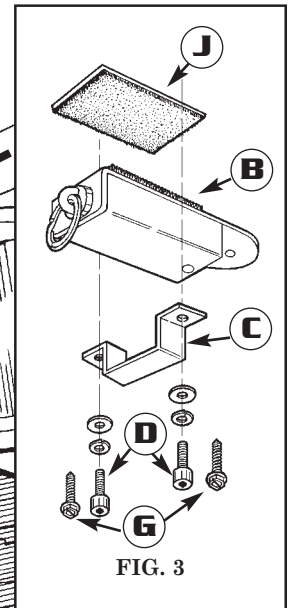

FIG. 3

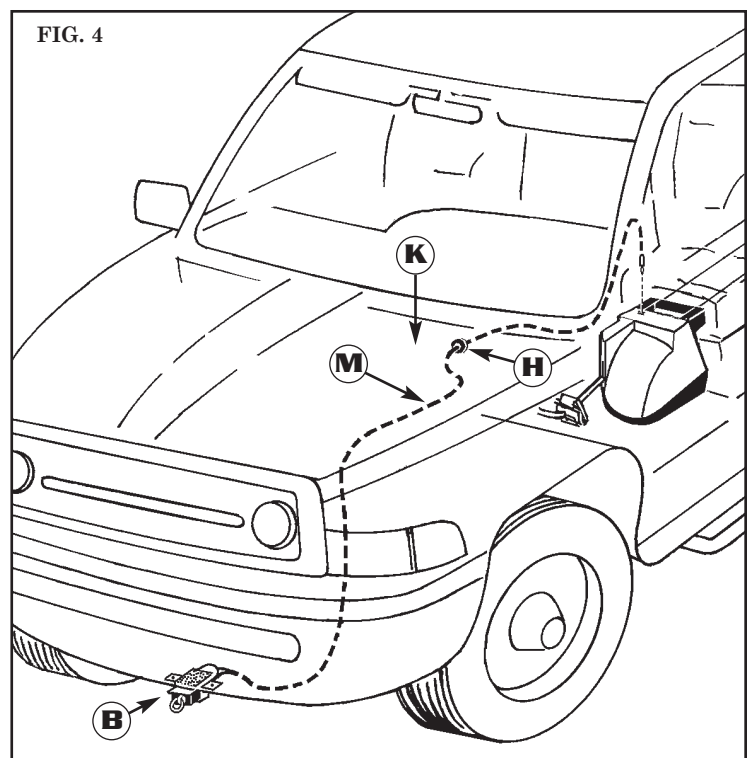

FIG. 4



BREAK AWAY INSTALLATION

Be careful not to drill into any functional components of the vehicle.

- Starting from the junction box (Fig. 4 / **B**), route the black electrical wire up to the firewall keeping it away from hot or moving engine components using the nylon ties (**I**) provided (Fig. 4 / **M**).
 - Feed the black wire through the hole in the firewall and into the passenger compartment (Fig. 5).
 - Place the split rubber grommet provided (**H**) over the black electrical wire (Fig. 6) and slide it into the 15/32" hole and fasten it into place (Fig. 7).
- NOTE:** Failure to properly install the 15/32" rubber grommet may result in harmful fumes entering the vehicle, or damage to the wires.

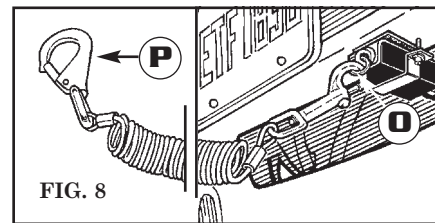
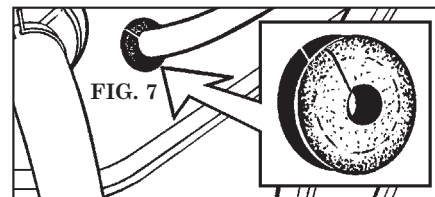
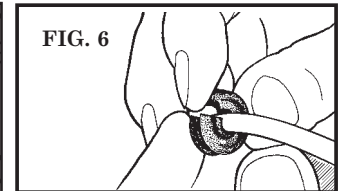
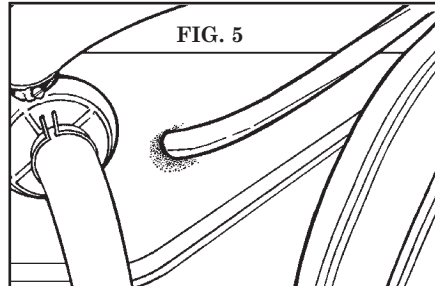

Using the Break-Away System

After attaching your towed vehicle to your coach and all hook-ups are complete, you will need to attach the break-away cable (**A**) from the junction box (**B**) to the motorhome. **On the motorhome end attach to a permanent location. The frame of the vehicle is recommended. DO NOT attach or wrap the cable around the tow bar, hitch or bumper.**

- Attach the small clip on the cable (**A**) to the loop on the pull pin of the junction box (Fig. 8 / **O**), and then attach the large clip to the motorhome (Fig. 8 / **P**). The coiled break-away cable fits all applications and needs no adjustment.
- Install the BrakeBuddy® in your towed vehicle and plug the junction box wire harness into the receptacle on top of the BrakeBuddy® (Fig. 9 / **q**).
- Before the start of every trip, pull the break-away pin to test that the break-away system activates the Brake Buddy®.
- When the use of the towed vehicle is needed, simply unhook the small clip from the loop on the pull pin of the junction box (**B**). Unplug the junction box wire harness from the BrakeBuddy® and coil the wire under the dashboard or under your floor mat (Fig. 10).

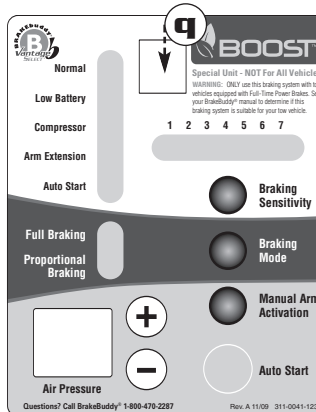

FIG. 9





SETUP

1. Attach the lock nut and clevis assembly to the air cylinder (Fig. 1).
2. Attach handle assembly to main unit (Fig. 2) with adjustment knob.
3. Adjust the driver's seat to the far back position (Fig. 2). Place the BrakeBuddy® on the floorboard.
4. With the notched end of the clevis facing up, attach the clevis to the top of the towed vehicle's brake pedal (Fig. 3). Angle the brake pedal clevis so the upper portion of the clevis grabs the top of the towed vehicle's brake pedal. Pull down on the lower portion of the clevis to extend the clevis under the bottom of the towed vehicle's brake pedal. Pull back very firmly on the red tab (A) until it locks into place securely. If attached correctly the clevis should be locked firmly around the vehicle's brake pedal.
5. Move the BrakeBuddy® forward until the Air Cylinder Arm is fully retracted (Fig. 4). Make sure the vehicle's brake pedal is not being pressed.
6. Adjust the driver's seat forward until it is less than a quarter inch away from the BrakeBuddy's® handle or loosely touching the handle (Fig. 5). Again, make sure the vehicle's brake pedal is not being pressed.
7. Power the BrakeBuddy® by plugging the unit into a 12-volt receptacle in the towed vehicle (Fig. 7). When powered, the air compressor will fill the air tank in under 1 minute. If a 12-volt power supply is not available in the towed position (or the 12-volt power remains off in the ignition off position), a 12-volt Battery Direct Kit is available (part number 39305). At a minimum, a 15-amp 12-volt power supply is required to operate the BrakeBuddy®.
8. Press the Manual Arm Activation button on the top BrakeBuddy panel®. The Manual Arm Activation button (Fig. 8 / C) will activate the arm one time and can be used to confirm that the unit is in the correct floor position. NOTE: The red "Auto Start" light will be lit until completion of step 10.
9. If needed adjust the BrakeBuddy® handle (Fig. 6). Loosen the adjustment knob on the back center portion of the BrakeBuddy® and adjust the height of the handle so it contacts the seat at the lowest position possible without sliding under

FIG. 1

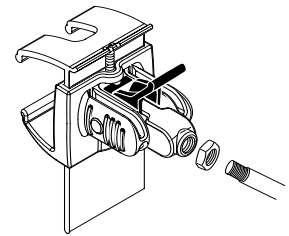

FIG. 2

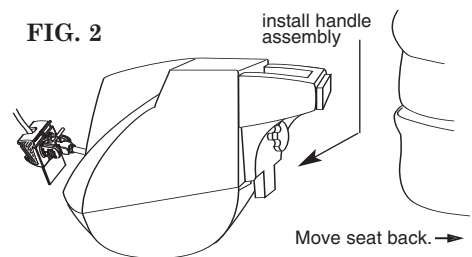

FIG. 3

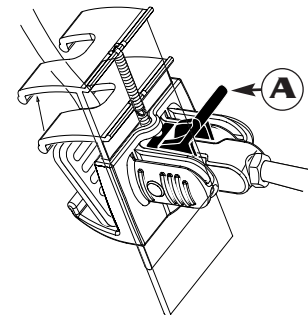

FIG. 4

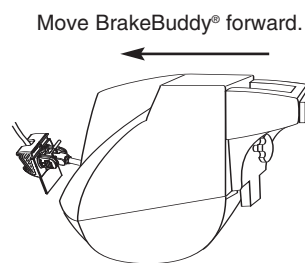

FIG. 5

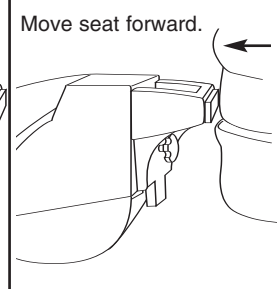
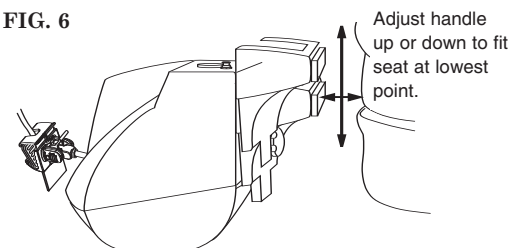

FIG. 6





Vantage Select Boost™



Phone (800) 470-2287

Brakebuddy.com

SETUP

the seat. (NOTE: the lower on the seat, the firmer the support). Tighten the adjustment knob to secure handle. Repeat step 6 until the seat is in the correct position.

If for some reason the BrakeBuddy® does not fit your vehicle properly, please call technical service at 1-800-470-2287.

NOTE: A rubber floor mat under the BrakeBuddy® will not allow the system to function properly and may result in damage. Please be sure a carpet floor mat is being used.

10. With vehicle's engine OFF, push the red AUTO START button located on top of the BrakeBuddy® (Fig. 8 / B). The arm will automatically extend / cycle 5 times. At this time the BrakeBuddy® is running through its diagnostics. While cycling be sure the BrakeBuddy® is in the correct position. BrakeBuddy® system will not operate until AUTOSTART button is pressed.

NOTE: While the arm is activating, look at the brake lights on the rear of the towed vehicle. The brake lights will fluctuate on and off as the BrakeBuddy® is pressing on and off the brake pedal. If the brake lights remain on, the BrakeBuddy® unit is too close to the brake pedal.

NOTE: After Auto Start cycle is complete, the red "Auto Start" light will go out and the green "normal" light will be on.

NOTE: The Manual Arm Activation button (Fig. 8 / C) will activate the arm one time and can be used to confirm that the unit is in the correct floor position.

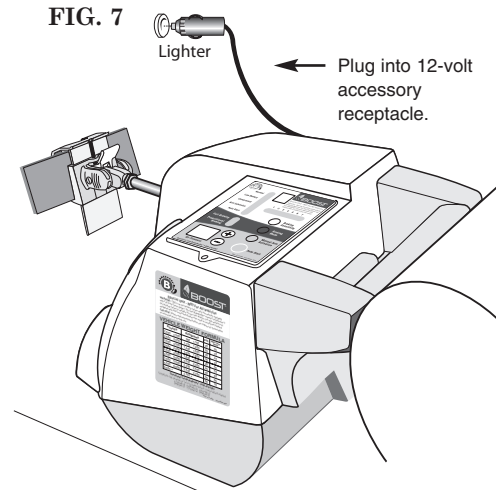
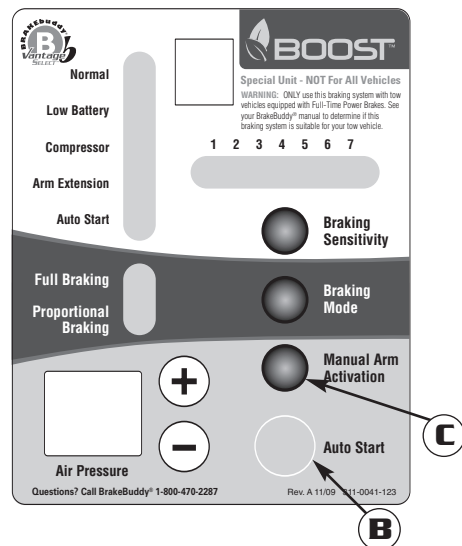

FIG. 8





Vantage Select Boost™



Phone (800) 470-2287

Brakebuddy.com

OPERATION INSTRUCTIONS

- Adjust the air pressure to match the weight of your towed vehicle. The braking pressure, or how hard your towed vehicle will brake in tow, is adjusted by the **+ / - Buttons** located on top of the BrakeBuddy® (Fig. 9). To find the correct pressure setting specific for your towed vehicle, please refer to the Vehicle Weight Formula Chart below. The display will adjust in increments or decrements of 1 when held down and displays air pressure from 20 to 90 PSI. After 5 minutes the display will "power down." Upon a button press, the display will "power on."

FIG. 9

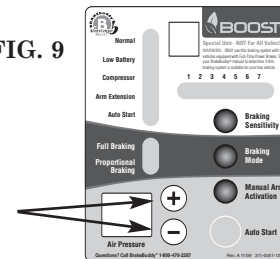

NOTE: The DIGITAL DISPLAY shows how much pressure is set to apply the brake; it does not display the air pressure inside the air tank that is automatically filled when the BrakeBuddy® is plugged into the 12-volt receptacle.

Choose your braking technology preference.

Full Braking Technology, also known as inertial style braking, fully employs the brakes when activated, taking the entire weight of the towed vehicle off of the motorhome brakes.

Proportional Braking Technology, when activated, performs the same braking force in the towed vehicle that is performed in the motorhome.

Remote:

- Install the AA battery (included) into the wireless remote system. Attach nonskid pad to the back of the remote system. Place remote and nonskid pad on a suitable semi-flat surface. The nonskid pad will secure the remote system.

FIG. 11

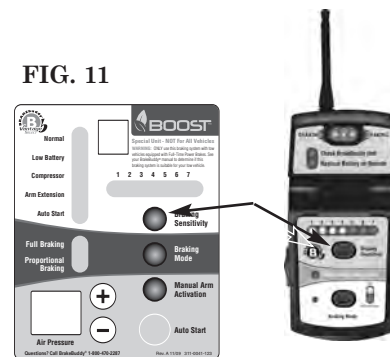

If you wish to change the braking technology preference, press the **Braking Mode Button** to select "Full" or "Proportional" braking. The braking preference can be changed while traveling.

Adjust the **Sensitivity Button** either on the remote or on top of the main BrakeBuddy® unit. The sensitivity button determines how hard you must apply the brakes in the motorhome before the BrakeBuddy® will engage the brakes in your towed vehicle. The sensitivity of the BrakeBuddy® is adjusted by each push of the **Sensitivity Button** (Fig. 11). The more lights that are illuminated, the easier the BrakeBuddy® will activate. Each time the BrakeBuddy® is installed, the sensitivity setting remains in the last used setting. Start at setting #4 and adjust to your preferred setting as you are driving (using the remote).

FIG. 12

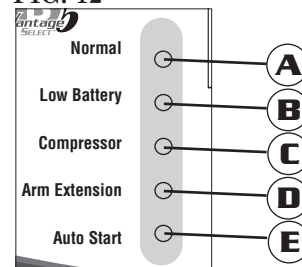

DIAGNOSTIC FEATURES:

The BrakeBuddy® Main Unit provides visual indication of problems that are occurring (Fig. 12).

- A - System Normal (present on main unit)
- B - Low Battery (battery voltage has dropped below 10 volts)
Recharge towed vehicle battery before traveling.
- C - Compressor Error (system is not pressurizing correctly) Call technical service immediately 1-800-470-2287.
- D - Arm Extension Error (arm is not retracted) Call technical service immediately 1-800-470-2287.
- E - Auto Start (Reminder to press AUTOSTART button before each trip)

VEHICLE WEIGHT FORMULA

Pounds	Kilograms	Psi.	With Tow Dolly
2,000 – 2,500	900 – 1,150	20	25
2,500 – 3,000	1,150 – 1,400	25	35
3,000 – 3,500	1,400 – 1,600	30	40
3,500 – 4,000	1,600 – 1,800	35	45
4,000 – 4,500	1,800 – 2,050	40	50
4,500 – 5,000	2,050 – 2,300	45	55
5,000 – 5,500	2,300 – 2,500	50	60
5,500 – 6,000	2,500 – 2,700	55	65
6,000 +	2,700 +	60	70

Questions? Call BrakeBuddy® 1-800-470-2287



OPERATION INSTRUCTIONS

The BrakeBuddy® Remote provides 2-way communication from the motorhome to the towed vehicle and provides visual indications of problems that are occurring (Fig. 13).

- F - Main Unit Error (red light will activate) Stop and check the main unit diagnostics for error.
- G - Breakaway Warning (red light and audible signal will activate) Stop Immediately!
- H - Battery Low on Remote (replace with new AA battery)
- I - On / Off Switch

NOTE: When the BrakeBuddy® system and motorhome are not in use, turn the remote on / off switch to the OFF position to conserve remote battery life.

A 12-volt DC power cord is also included. This bypasses the on/off switch, and battery removal when using the 12-volt DC cord is not required.

NOTE: When done towing and parked, we recommend you unplug the BrakeBuddy® system from the towed vehicle 12-volt receptacle. If that is undesirable, recharge the towed vehicle battery once every 3 days to maintain optimum battery condition. A Towed Vehicle Battery Maintainer (#39332) is available if you would like to avoid recharging your towed vehicle's battery. The Towed Vehicle Battery Maintainer continuously maintains the towed vehicle's battery charge. Contact your local dealer or Brakebuddy to order.

REMOTE SYNCHRONIZE PROCEDURE:

This device works similarly to a universal garage door opener. If this remote ever becomes un-synced with the main unit, simply perform the following procedure:

1. Power up / turn on both devices (dinghy and remote).
2. On the BrakeBuddy® unit, hold down the (+) and (-) buttons simultaneously until the Air Pressure setting reads "LL" (Fig. 14 / K).
3. Next, with the remote, hold down the Sensitivity and Braking Mode buttons simultaneously for 5 seconds.

NOTE: User has 5 seconds to synchronize the remote once "LL" is displayed.

4. Once the dinghy has completed the "link-up" routine, the air pressure display will change from "LL" to the last air pressure setting (# between 20 and 90).

5. Both the dinghy and coach units should be displaying the same sensitivity setting and sensitivity button presses on either unit should cause both units to update to the new setting.

FIG. 13



FIG. 14

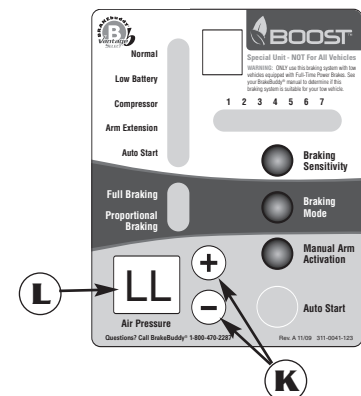



Vantage Select Boost™



Phone (800) 470-2287

Brakebuddy.com

REMOVAL INSTRUCTIONS

1. To remove the BrakeBuddy® from your towed vehicle, unplug the 12-volt adapter from the towed vehicle (the air pressure in the system will automatically drain).
2. Unplug the breakaway junction box harness from the top of the BrakeBuddy® and coil the wire under the dashboard or floor mat.
3. Adjust the seat back and remove the clevis after the air pressure has drained.
4. Disconnect (unclip) the breakaway safety coil from the breakaway junction box.

Information to User:

NOTE: This equipment has been tested and found to comply with the limits for a Class B digital device, pursuant to part 15 of the FCC Rules. These limits are designed to provide reasonable protection against harmful interference in a residential installation. FCC Radiation Exposure Statement to comply with FCC RF exposure requirements in section 1.1307, a minimum separation distance of 1.40 cm (0.6 inches) is required between the antenna and all persons. This equipment generates, uses and can radiate radio frequency energy and, if not installed and used in accordance with the instructions, may cause harmful interference to radio communications. However, there is no guarantee that interference will not occur in a particular installation. If this equipment does cause harmful interference to radio or television reception, which can be determined by turning the equipment off and on, the user is encouraged to try to correct the interference by one or more of the following measures:

- Reorient or relocate the receiving antenna.
- Increase the separation between the equipment and receiver.
- Connect the equipment into an outlet on a circuit different from that to which the receiver is connected.
- Consult the dealer or an experienced radio / TV technician for help.

CAUTION: Changes or modifications not expressly approved by Hopkins Manufacturing Corporation could void the user's authority to operate the equipment.



TROUBLESHOOTING

- Problem:** The air compressor will not come on after I plug in the BrakeBuddy®.
Solution: Make sure there is power to the 12-volt receptacle and the fuse for the 12-volt plug is functioning. If both are functioning, the red indicator light on the 12-volt plug will be lit when it is plugged in. To remove the fuse on the BrakeBuddy®'s power cord, unscrew the finger nut on the end of the plug. Replace fuse with a 15 amp fuse.
- NOTE: BrakeBuddy® is designed with an automatic shut-off on the compressor when voltage drops to 9.5 volts.
- Problem:** The BrakeBuddy® will not apply the brakes in the towed vehicle.
Solution: Make sure the air pressure is properly adjusted for the weight of the towed vehicle. Also check the sensitivity setting.
- Problem:** The BrakeBuddy® applies the brakes too hard in my towed vehicle.
Solution: Reduce the air pressure by manually depressing the (-) button.
- Problem:** The BrakeBuddy® applies the brake as soon as I plug it in.
Solution: Check that the break-away system is properly connected and the pin is plugged into the junction box.
- Problem:** The compressor pumps up and then keeps on pumping slowly.
Solution: There may not be enough current to the BrakeBuddy®. You may have a weak battery or you may need a "12-volt Battery Direct Kit" (part number 39305). At a minimum, a 15-amp 12-volt cigarette lighter or auxiliary power plug is required to operate the BrakeBuddy®.
- Problem:** I have to apply the brakes in my motorhome very hard for the Brake Buddy to come on.
Solution: Increase the sensitivity of the BrakeBuddy® by pressing the sensitivity button.
- Problem:** The BrakeBuddy® turns my brake lights on even though I am not applying the brakes in my motorhome.
Solution: The BrakeBuddy® may be too close to the brake pedal thereby activating the brake lights.
- Problem:** The BrakeBuddy's® compressor runs for more than three minutes at a time.
Solution: The unit may have low power. Contact BrakeBuddy® customer support for further instructions 1-800-470-2287.
- Problem:** I'm experiencing frequent battery drain on my towed vehicle.
Solution: Battery drain can depend on your braking style and vehicle type. We recommend recharging the car battery once every three days to maintain optimum battery condition. Another solution is to install the Towed Vehicle Battery Maintainer (#39332). This accessory item continuously maintains the towed vehicle's battery charge. Contact your local dealer or BrakeBuddy to order.



Vantage Select Boost™



Phone (800) 470-2287

Brakebuddy.com

LIMITED THREE-YEAR WARRANTY

Hopkins Manufacturing Corporation thanks you for purchasing BrakeBuddy®. A 3-year limited warranty and a 30-day money back guarantee apply to your BrakeBuddy® and BrakeBuddy® accessories. An additional 2-year extended warranty is also available (part number 39307). We wish you safe and happy travels.

WHAT IS COVERED AND FOR HOW LONG?

We are confident our product will perform well and therefore warrant to you, as the original retail purchaser, for a period of three years from the date of original purchase, that your new product will be free of mechanical and electrical defects in material and workmanship.

WHAT WILL BRAKEBUDDY® DO? HOW DO I GET SERVICE?

During the warranty period, we will repair or replace your new product (at our option), which will be your exclusive remedy under this warranty. **Please do not return this product to the place of purchase. Doing so may delay the processing of your claim and our repair of your product. Call BrakeBuddy® Technical Service for return instructions 1-800-470-2287. Return your product postage prepaid with proof of purchase and a short description of the problem after calling BrakeBuddy®.**

WHAT IS NOT COVERED?

Our warranty for your product will not cover damage resulting from neglect or misuse of the product, use of improper voltage or current, use contrary to operating instructions, or disassembly, repair, or alteration by any person other than an authorized service station. Any implied warranty of merchantability or fitness for a particular purpose of your product is limited to the duration of this written warranty. We shall not be liable for any incidental or consequential damages for breach of any expressed or implied warranty on your product.

HOW YOUR STATE'S LAWS MAY APPLY:

Some states do not allow limitations on how long an implied warranty lasts or the exclusion or limitation of incidental or consequential damages, so the above limitation may not apply to you. This warranty gives you specific legal rights, and you may also have other rights, which vary from state to state.

NOTE: The BrakeBuddy® Break-Away System (part # 39327) must be used to uphold your warranty. BrakeBuddy® cannot support your warranty if the Break-Away System is not produced by Hopkins Manufacturing/BrakeBuddy®. If your Break-Away System needs to be replaced please call BrakeBuddy® at 1-800-2287.

“This device complies with Part 15 of the FCC Rules. Operation is subject to the following two conditions: (1) This device may not cause harmful interference, and (2) this device must accept any interference received, including interference that may cause undesired operation.”